



TSF18N50MD

500V N-Channel MOSFET

General Description

This Power MOSFET is produced using Truesemi's advanced planar stripe DMOS technology. This advanced technology has been especially tailored to minimize on-state resistance, provide superior switching performance, and withstand high energy pulse in the avalanche and commutation mode. These devices are well suited for high efficiency switched mode power supplies, active power factor correction based on half bridge topology.

Features

- 18.0A,500V,Max. $R_{DS(on)}=0.32\ \Omega$ @ $V_{GS}=10V$
- Low gate charge(typical 45nC)
- High ruggedness
- Fast switching
- 100% avalanche tested
- Improved dv/dt capability

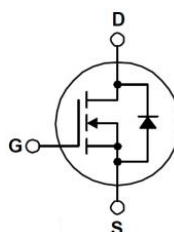

Absolute Maximum Ratings $T_C=25^\circ\text{C}$ unless otherwise specified

Symbol	Parameter	Value	Units
V_{DSS}	Drain-Source Voltage	500	V
V_{GS}	Gate-Source Voltage	± 30	V
I_D	Drain Current	$T_C = 25^\circ\text{C}$	18*
		$T_C = 100^\circ\text{C}$	10.8*
I_{DM}	Pulsed Drain Current (Note 1)	72*	A
E_{AS}	Single Pulsed Avalanche Energy (Note 2)	945	mJ
E_{AR}	Repetitive Avalanche Energy (Note 1)	23.5	mJ
dv/dt	Peak Diode Recovery dv/dt (Note 3)	4.5	V/ns
P_D	Power Dissipation ($T_C = 25^\circ\text{C}$) -Derate above 25°C	38.5	W
		0.3	W/ $^\circ\text{C}$
T_J, T_{STG}	Operating and Storage Temperature Range	-55 to +150	$^\circ\text{C}$
T_L	Maximum lead temperature for soldering purposes, 1/8" from case for 5 seconds	300	$^\circ\text{C}$

* Drain current limited by maximum junction temperature.

Thermal Resistance Characteristics

Symbol	Parameter	Value	Units
$R_{\theta JC}$	Thermal Resistance,Junction-to-Case	3.3	$^\circ\text{C}/\text{W}$
$R_{\theta CS}$	Thermal Resistance,Case-to-Sink Typ.	--	$^\circ\text{C}/\text{W}$
$R_{\theta JA}$	Thermal Resistance,Junction-to-Ambient	62.5	$^\circ\text{C}/\text{W}$

Electrical Characteristics $T_C=25\text{ }^\circ\text{C}$ unless otherwise specified

Symbol	Parameter	Test Conditions	Min	Typ	Max	Units
--------	-----------	-----------------	-----	-----	-----	-------

On Characteristics

V_{GS}	Gate Threshold Voltage	$V_{DS} = V_{GS}, I_D = 250\text{ }\mu\text{A}$	2.0	--	4.0	V
$R_{DS(ON)}$	Static Drain-Source On-Resistance	$V_{GS} = 10\text{ V}, I_D = 9.0\text{ A}$	--	0.25	0.32	Ω
g_{FS}	Forward Transconductance	$V_{DS} = 40\text{ V}, I_D = 9.0\text{ A}$	--	25	--	S

Off Characteristics

BV_{DSS}	Drain-Source Breakdown Voltage	$V_{GS} = 0\text{ V}, I_D = 250\text{ }\mu\text{A}$	500	--	--	V
$\Delta BV_{DSS} / \Delta T_J$	Breakdown Voltage Temperature Coefficient	$I_D = 250\text{ }\mu\text{A}$, Referenced to $25\text{ }^\circ\text{C}$	--	0.5	--	$\text{V}/^\circ\text{C}$
I_{DSS}	Zero Gate Voltage Drain Current	$V_{DS} = 500\text{ V}, V_{GS} = 0\text{ V}$	--	--	1	μA
		$V_{DS} = 400\text{ V}, T_C = 125\text{ }^\circ\text{C}$	--	--	10	μA
I_{GSSF}	Gate-Body Leakage Current, Forward	$V_{GS} = 30\text{ V}, V_{DS} = 0\text{ V}$	--	--	100	nA
I_{GSSR}	Gate-Body Leakage Current, Reverse	$V_{GS} = -30\text{ V}, V_{DS} = 0\text{ V}$	--	--	-100	nA

Dynamic Characteristics

C_{iss}	Input Capacitance	$V_{DS} = 25\text{ V}, V_{GS} = 0\text{ V},$ $f = 1.0\text{ MHz}$	--	3400	--	pF
C_{oss}	Output Capacitance		--	250	--	pF
C_{riss}	Reverse Transfer Capacitance		--	34	--	pF

Switching Characteristics

$t_{d(on)}$	Turn-On Time	$V_{DS} = 250\text{ V}, I_D = 18.0\text{ A},$ $R_G = 25\text{ }\Omega$ (Note 4)	--	60	--	ns
t_r	Turn-On Rise Time		--	160	--	ns
$t_{d(off)}$	Turn-Off Delay Time		--	84	--	ns
t_f	Turn-Off Fall Time		--	84	--	ns
Q_g	Total Gate Charge	$V_{DS} = 400\text{ V}, I_D = 18.0\text{ A},$ $V_{GS} = 10\text{ V}$ (Note 4)	--	42	--	nC
Q_{gs}	Gate-Source Charge		--	12	--	nC
Q_{gd}	Gate-Drain Charge		--	18	--	nC

Source-Drain Diode Maximum Ratings and Characteristics

I_S	Continuous Source-Drain Diode Forward Current	--	--	18	A	
I_{SM}	Pulsed Source-Drain Diode Forward Current	--	--	72		
V_{SD}	Source-Drain Diode Forward Voltage	$I_S = 18.0\text{ A}, V_{GS} = 0\text{ V}$	--	--	1.4	V
t_{rr}	Reverse Recovery Time	$I_S = 18.0\text{ A}, V_{GS} = 0\text{ V}$ $di_F/dt = 100\text{ A}/\mu\text{s}$	--	500	--	ns
Q_{rr}	Reverse Recovery Charge		--	5.4	--	μC

NOTES:

1. Repetitive Rating: Pulse width limited by maximum junction temperature
2. $L=5.2\text{ mH}, I_{AS}=18.0\text{ A}, V_{DD}=50\text{ V}, R_G=25\text{ }\Omega$, Starting $T_J=25\text{ }^\circ\text{C}$
3. $I_{SD} \leq 18.0\text{ A}, di/dt \leq 200\text{ A}/\mu\text{s}, V_{DD} \leq BV_{DSS}$, Starting $T_J = 25\text{ }^\circ\text{C}$
4. Essentially Independent of Operating Temperature Typical Characteristics

Typical Characteristics

Figure 1. On-Region Characteristics

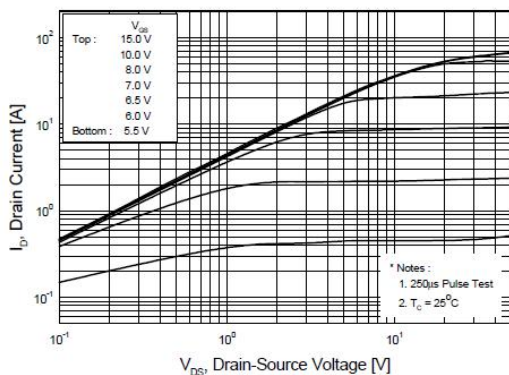

Figure 2. Transfer Characteristics

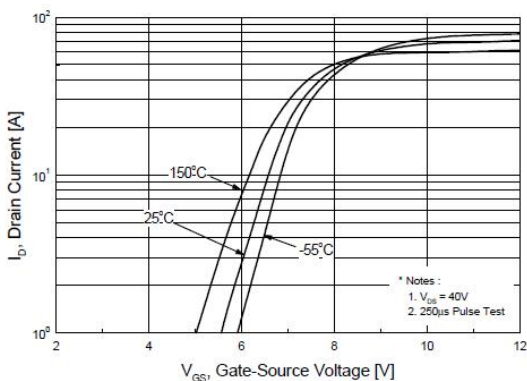

Figure 3. On-Resistance Variation vs. Drain Current and Gate Voltage

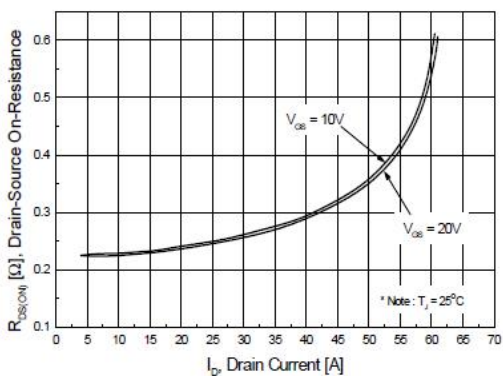

Figure 4. Body Diode Forward Voltage Variation vs. Source Current and Temperature

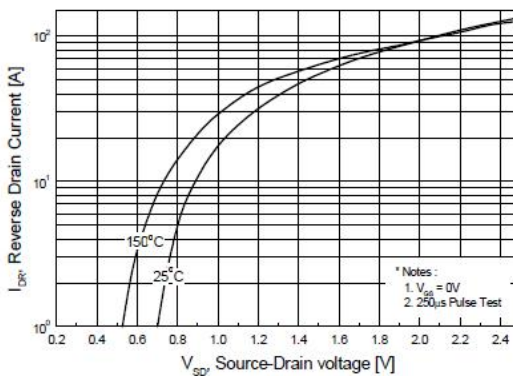

Figure 5. Capacitance Characteristics

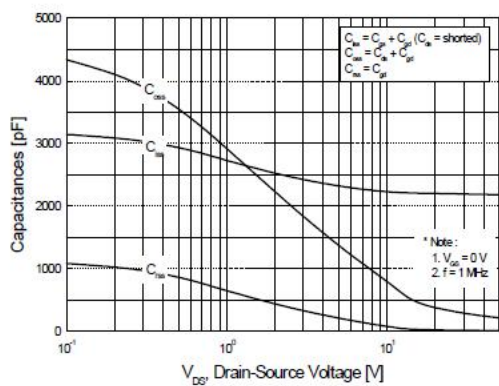
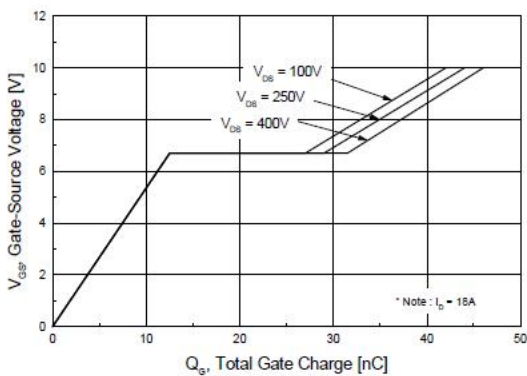

Figure 6. Gate Charge Characteristics



Typical Characteristics

Figure 7. Breakdown Voltage Variation vs. Temperature

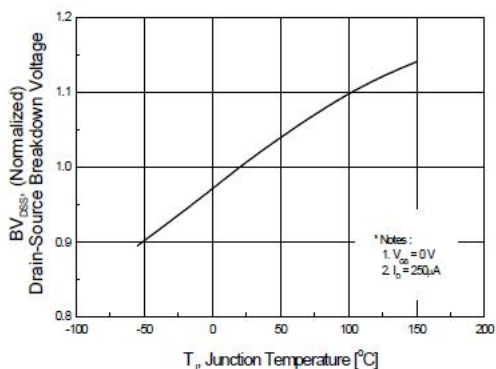

Figure 8. On-Resistance Variation vs. Temperature

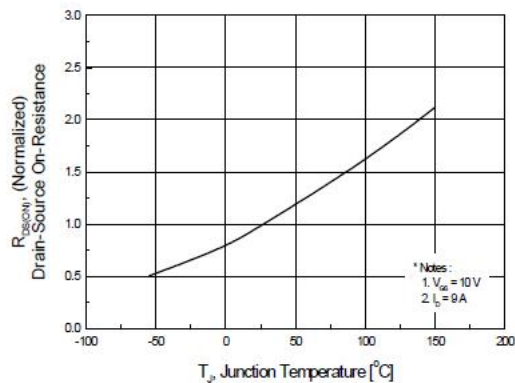

Figure 9. Maximum Safe Operating Area

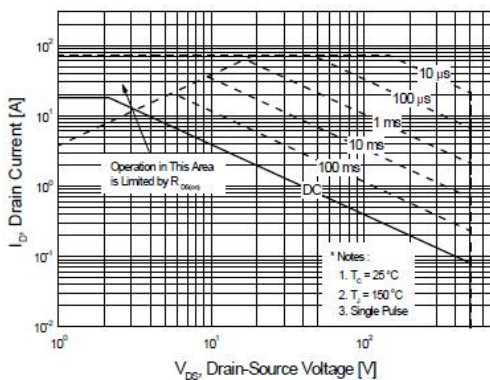

Figure 10. Maximum Drain Current vs. Case Temperature

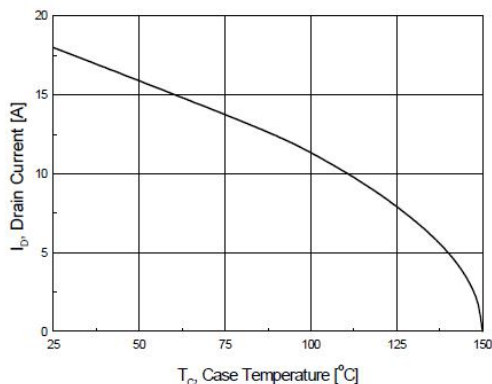

Figure 11. Transient Thermal Response Curve

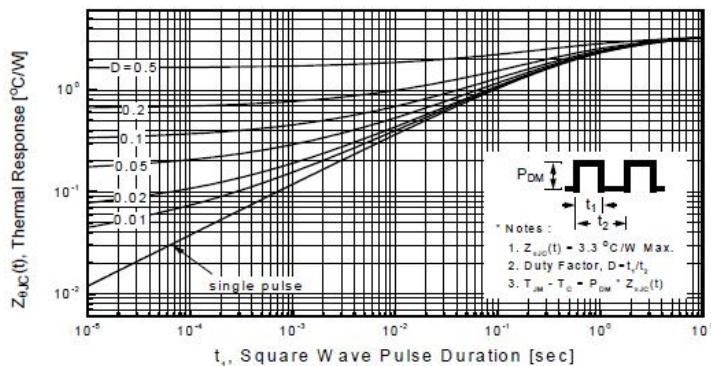

Fig 12. Gate Charge Test Circuit & Waveform

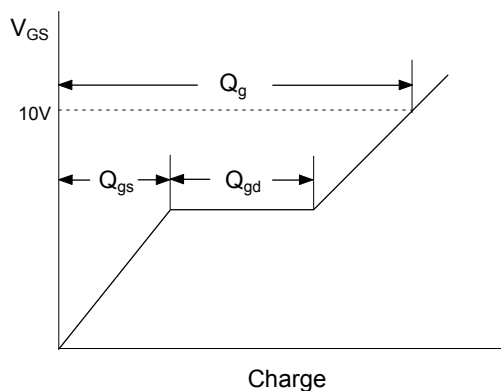
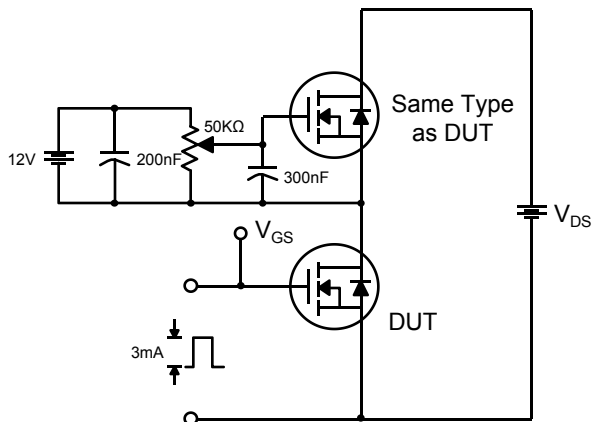

Fig 13. Resistive Switching Test Circuit & Waveforms

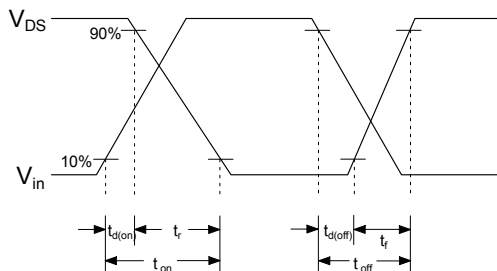
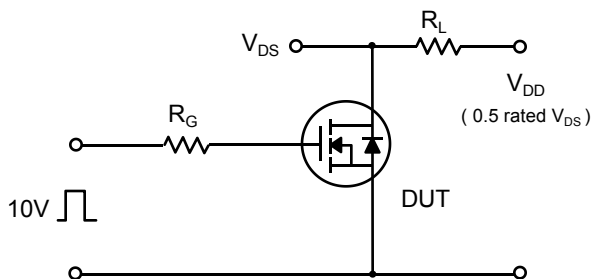

Fig 14. Unclamped Inductive Switching Test Circuit & Waveforms

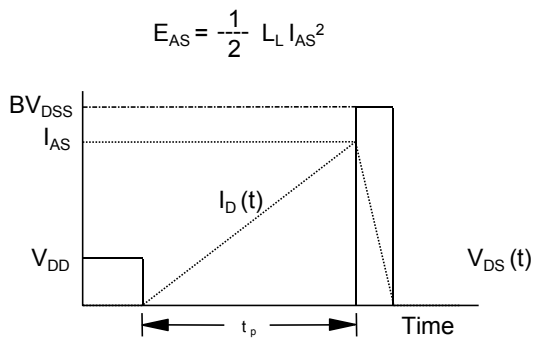
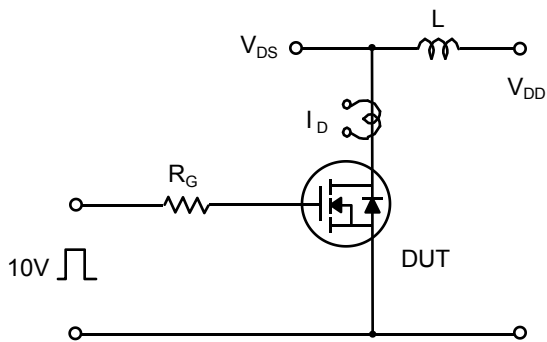

Fig 15. Peak Diode Recovery dv/dt Test Circuit & Waveforms

